

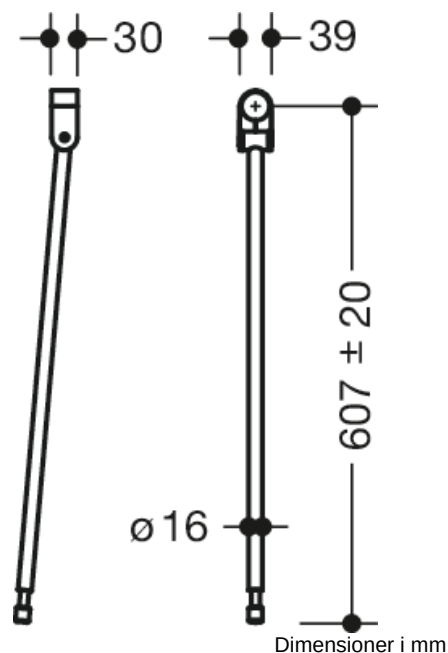

Lignende Billede



## Egenskaber

### Gulvstøtte

- Lodret gulvstøtte til eftermontering på foldbare støttehåndtag og vægstøtتهåndtag 801.50...
- Monteringshøjde 760 mm (for at opfylde højdekrav i henhold til DIN 18040)
- Nem montering
- Forbindelse lavet af højglanspolyamid i henhold til HEWI's farvekort
- Støtte lavet af rustfrit stål af høj kvalitet, Mat slebet overflade
- Lodret længde 607 mm
- Højdejustering i området +/- 20 mm mulig
- er produceret i overensstemmelse med CE- og UKCA-forordningen (EU) 2017/745 om medicinsk udstyr















## Priser og udmærkelser



## Certifikater



## Farver/Overflader

 99 (ren hvid)	 92 (antracitgrå)	 74 (æblegrønt)	 33 (rubinrød)
 98 (signal hvid)	 90 (dyb sort)	 55 (aquablå)	 18 (sennepsgul)
 97 (lys grå)	 86 (sand)	 50 (stålblå)	
 95 (klippe grå)	 84 (umbra)	 36 (koral)	