

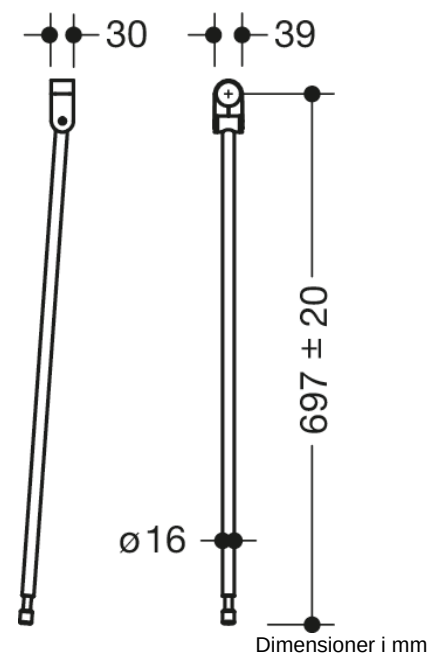

Lignende Billede



Egenskaber

Gulvstøtte

- Lodret gulvstøtte til eftermontering på foldbare støttehåndtag og vægstøttehåndtag 801.50...
- Monteringshøjde 850 mm (for at opfylde højdekravene i henhold til ÖNORM B 1600)
- Nem montering
- Forbindelse lavet af højglanspolyamid i henhold til HEWI's farvekort
- Støtte lavet af rustfrit stål af høj kvalitet, Mat slebet overflade
- lodret længde 697 mm
- Højdejustering i området +/- 20 mm mulig
- er produceret i overensstemmelse med CE- og UKCA-forordningen (EU) 2017/745 om medicinsk udstyr















Priser og udmærkelser



Certifikater



Farver/Overflader

 99 (ren hvid)	 92 (antracitgrå)	 74 (æblegrønt)	 33 (rubinrød)
 98 (signal hvid)	 90 (dyb sort)	 55 (aquablå)	 18 (sennepsgul)
 97 (lys grå)	 86 (sand)	 50 (stålblå)	
 95 (klippe grå)	 84 (umbra)	 36 (koral)	