

Lignende Billede

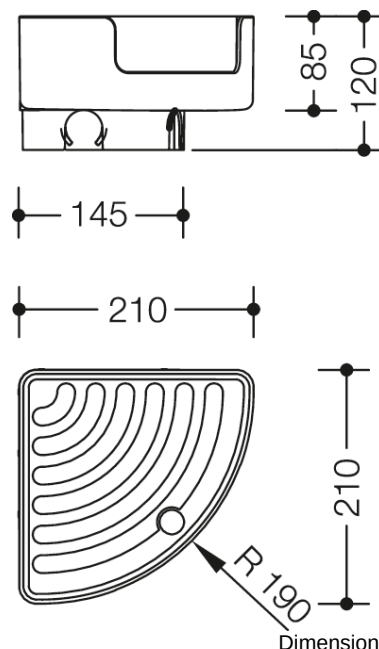

Egenskaber

Serie 802 LifeSystem-hjørnehylde

















- Rektangulær hylde formet som en kvart cirkel med høje sidevægge og vandafløb
- tjener til opbevaring af tilbehør
- Udsparring på forsiden
- Belastningskapacitet 3 kg
- Gulv med hældning til vandafledning og skridsikker profil
- til montering på stangsystem diameter 33 mm
- Sidelængder 210 mm, 120 mm høj
- fremstillet af polyamid i høj kvalitet i henhold til HEWI's farvekort

Priser og udmærkelser



reddot design award
winner 2003

Farver/Overflader

 99 (ren hvid)	 92 (antracitgrå)	 74 (æblegrønt)	 36 (koral)
 98 (signal hvid)	 90 (dyb sort)	 72 (maj grøn)	 33 (rubinrød)
 97 (lys grå)	 86 (sand)	 55 (aquablå)	 24 (orange)
 95 (klippe grå)	 84 (umbra)	 50 (stålblå)	 18 (sennepsgul)