

MOBILE HINGED SEATS

NECESSARY

OPTIONAL
SEPARATELY

R 380 **950.51.42590***

- wall bracket made of stainless steel, chrome-plated
- seat made of glass fibre reinforced polyamide in colours white or anthracite grey



350 **950.51.40590***

- wall bracket made of stainless steel, chrome-plated
- seat made of glass fibre reinforced polyamide in colours white or anthracite grey



450 **950.51.41590***

- wall bracket made of stainless steel, chrome-plated
- seat made of glass fibre reinforced polyamide in colours white or anthracite grey



R 380 **950.51.420XA***

- wall bracket made of stainless steel, satin finish
- seat made of glass fibre reinforced polyamide in colours white or anthracite grey



350 **950.51.400XA***

- wall bracket made of stainless steel, satin finish
- seat made of glass fibre reinforced polyamide in colours white or anthracite grey

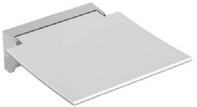

450 **950.51.410XA***

- wall bracket made of stainless steel, satin finish
- seat made of glass fibre reinforced polyamide in colours white or anthracite grey



R 380 **950.51.42090***

- wall bracket made of stainless steel, white powder-coated
- seat made of glass fibre reinforced polyamide in white

950.51.42190* do. in anthracite grey



350 **950.51.40090***

- wall bracket made of stainless steel, white powder-coated
- seat made of glass fibre reinforced polyamide in white

950.51.40190* do. in anthracite grey

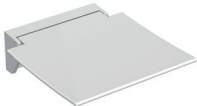

450 **950.51.41090***

- wall bracket made of stainless steel, white powder-coated
- seat made of glass fibre reinforced polyamide in white

950.51.41190* do. in anthracite grey



+

+

+

950.51.01440

- made of stainless steel, chrome-plated



950.51.014XA

- made of stainless steel, satin finish

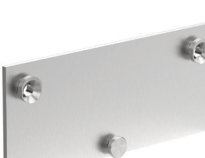

950.51.01590

- made of polyamide in HEWI colours 98 (signal white) or 99 (pure white)



OPTIONAL

OPTIONAL

OPTIONAL

950.51.01540

- cover for covering fixed mounting plates
- face plate made of stainless steel, mirror polished
- cover frame made of polyamide in HEWI colour 98 (signal white)



950.51.015XA

- cover for covering fixed mounting plates
- face plate made of stainless steel, satin finish
- cover frame made of polyamide in HEWI colours 90 (jet black), 92 (anthracite grey), 98 (signal white) or 99 (pure white)



950.51.01590

- cover for covering fixed mounting plates
- made of polyamide in HEWI colours 98 (signal white) or 99 (pure white)



* Available until 31/10/2025.

OR SET

NECESSARY FOR ALL

OPTIONAL FOR ALL

OR

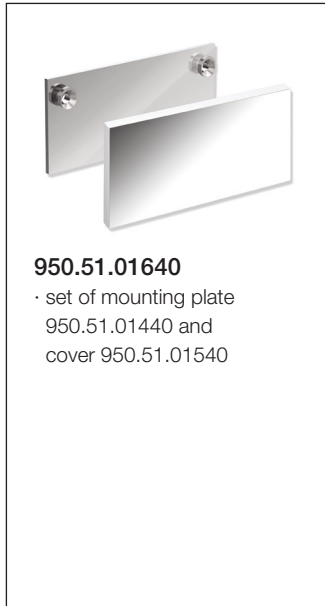

950.51.01640
· set of mounting plate 950.51.01440 and cover 950.51.01540

+

OR

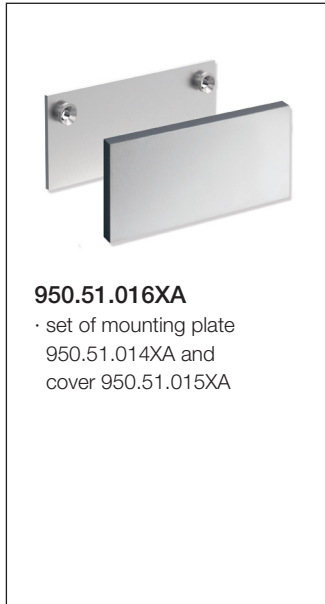

950.51.016XA
· set of mounting plate 950.51.014XA and cover 950.51.015XA

+

OR

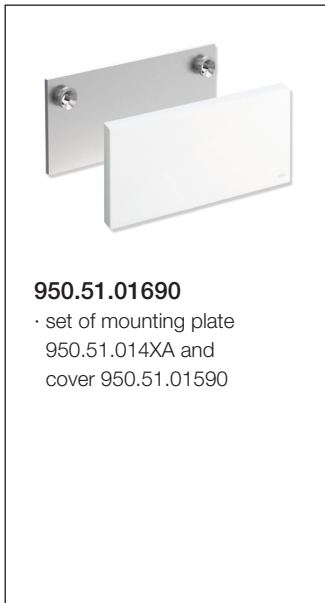

950.51.01690
· set of mounting plate 950.51.014XA and cover 950.51.01590

+

BM17.2
For fixing on walls made of concrete (> C20/C25)
National technical approval number: ETA-11/0493

additionally:
injection mortar (HEWI item No.: 200311)
or to be provided on site:
injection mortar HIT-HY200A (Hilti)
extrusion tool HDM (Hilti)

BM10.2
For fixing on walls made of concrete (> C20/C25)

BM11.2
For fixing on walls made of autoclaved aerated concrete (> P2)

additionally:
injection mortar (HEWI item No.: 200266)
conical drill bit (HEWI item No.: 171041)
or to be provided on site:
injection mortar HIT-HY 270 (Hilti)
extrusion tool HDM (Hilti)
conical drill bit TE-C PB 22/100 (Hilti)

BM12.2
For fixing on lightweight walls with rear lining made of laminated timber boards (with waterproof bonding, at least 30 mm thick required, e.g. studs or prewall installation)

BM13.2
For fixing on lightweight walls with integrated steel plates (e.g. studs or pre wall installation)

BM18.2
For fixing on walls made of:
· solid bricks
· perforated calcium silicate block
· hollow concrete block
· vertically perforated bricks
· hollow lightweight concrete block
· lightweight aggregate concrete with open structure

National technical approval number: ETA-13/1036

additionally:
injection mortar (HEWI item No.: 200266)
or to be provided on site:
injection mortar HIT-HY 270 (Hilti)
extrusion tool HDM (Hilti)

OPTIONAL



Protection and storage bag

950.51.013
· made of high-quality, tearresistant white synthetic material sheeting
· high-quality fleece lining on the inside to protect the seat surfaces

OPTIONAL



Fixed mountable backrest

950.51.02090
· made of glass fibre reinforced polyamide in colours white or anthracite grey

OPTIONAL