

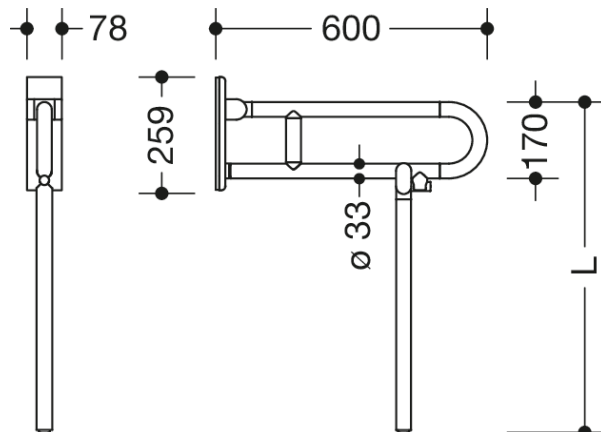

Similar picture



Dimensions in mm

Properties

Series 801 mobile folding support handle

- with customised floor support
- Two parallel rails, arranged on top of each other, bars joined together by a connecting arch
- Used for holding and supporting
- Can be folded upwards and folded downwards with braked movement
- for mobile use
- for easy and flexible retrofitting on existing, preassembled mounting plate: 950.50.016, must be ordered separately
- toolless and quick installation by simple attachment of the hinged support rail
- secured by fixing screw to prevent unintentional removal
- tested up to 150 kg when used with HEWI fixing material
- Recommended maximum weight of the user: 150 kg
- Projection 600 mm , Height 252 mm and width 78 mm , Rail 33 mm in diameter
- With continuous, corrosion-protected steel core - made of high-quality polyamide according to HEWI colour chart
- WC paper holder 801.50.011 and WC flush release (radio) 801.50.060 can be retrofitted
- is produced in accordance with CE and UKCA Regulation (EU) 2017/745 on medical devices









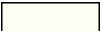

Awards

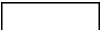

Certificates



Colours / Surfaces

| | | | | | |
|---|-------------------|---|----------------------|---|---------------------|
|  | 99 (pure white) |  | 92 (anthracite grey) |  | 55 (aqua blue) |
|  | 98 (signal white) |  | 90 (jet black) |  | 50 (steel blue) |
|  | 97 (light grey) |  | 86 (sand) |  | 33 (ruby red) |
|  | 95 (stone grey) |  | 84 (umber) |  | 18 (mustard yellow) |