

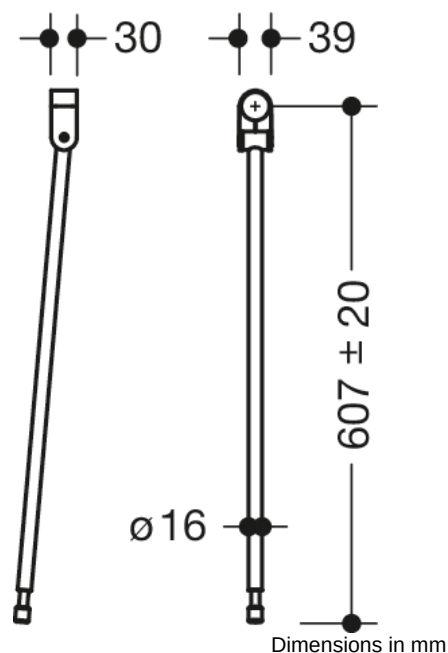

Similar picture



Properties

Floor support

- vertical floor support for retrofitting on hinged support rails and stationary support rails 801.50...
- installation height 760 mm (to fulfil the DIN 18040 height requirements)
- easy installation
- connection made of high-quality polyamide according to HEWI colour chart
- support made of high-quality stainless steel with satin
- vertical length 607 mm
- height adjustment within +/- 20 mm range possible
- produced in accordance with CE- and UKCA-Regulation (EU) 2017/745 on medical devices













Awards



Certificates



Colours / Surfaces

 99 (pure white)	 92 (anthracite grey)	 74 (apple green)	 33 (ruby red)
 98 (signal white)	 90 (jet black)	 55 (aqua blue)	 18 (mustard yellow)
 97 (light grey)	 86 (sand)	 50 (steel blue)	
 95 (stone grey)	 84 (umber)	 36 (coral)	