

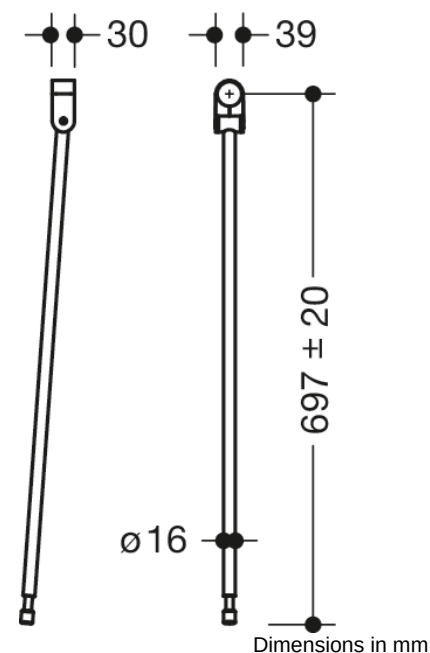

Similar picture



### Properties

Floor support

- vertical floor support for retrofitting on hinged support rails and stationary support rails 801.50...
- mounting height 850 mm (for fulfilling the ÖNORM B 1600 requirements)
- easy installation
- Connection made of high-quality polyamide according to HEWI colour chart
- support made of high-quality stainless steel with satin finish
- vertical length 697 mm
- height adjustment within +/- 20 mm range possible
- produced in accordance with CE- and UKCA-Regulation (EU) 2017/745 on medical devices













### Awards



### Certificates



### Colours / Surfaces

 99 (pure white)	 92 (anthracite grey)	 74 (apple green)	 33 (ruby red)
 98 (signal white)	 90 (jet black)	 55 (aqua blue)	 18 (mustard yellow)
 97 (light grey)	 86 (sand)	 50 (steel blue)	
 95 (stone grey)	 84 (umber)	 36 (coral)	