

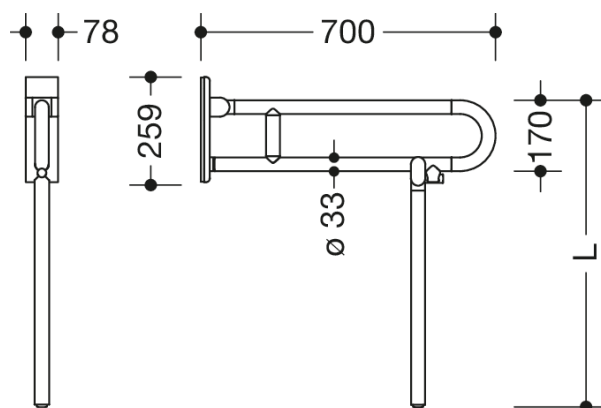

Similar picture



Dimensions in mm

### Properties

Series 801 mobile folding support handle (rotatable)

- with customised floor support
- Two parallel rails, arranged on top of each other, bars joined together by a connecting arch
- Used for holding and supporting
- Can be folded upwards and, folded downwards with braking mechanism, in raised position can be turned to left or right towards the wall
- for mobile use
- for easy and flexible retrofitting on existing, preassembled mounting plate: 950.50.016, must be ordered separately
- toolless and quick installation by simple attachment of the hinged support rail
- secured by fixing screw to prevent unintentional removal
- tested up to 150 kg when used with HEWI fixing material
- Recommended maximum weight of the user: 150 kg
- Projection 700 mm , Height 252 mm and width 78 mm , Rail 33 mm in diameter
- With continuous, corrosion-protected steel core - made of high-quality polyamide according to HEWI colour chart
- Toilet roll holder 801.50.011, WC flush release (radio) 801.50.060 retrofittable
- is produced in accordance with CE and UKCA Regulation (EU) 2017/745 on medical devices

### Awards



### Certificates



### Colours / Surfaces

	99 (pure white)		92 (anthracite grey)		55 (aqua blue)
	98 (signal white)		90 (jet black)		50 (steel blue)
	97 (light grey)		86 (sand)		33 (ruby red)
	95 (stone grey)		84 (umber)		18 (mustard yellow)