

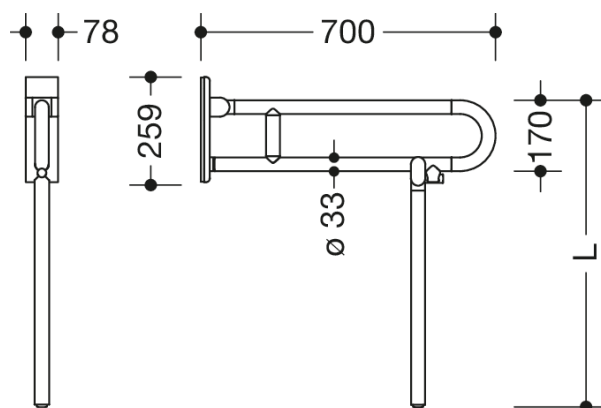

Similar picture



Dimensions in mm

Properties

Series 801 mobile folding support handle

- with customised floor support
- Two parallel rails, arranged on top of each other, bars joined together by a connecting arch
- Used for holding and supporting
- Can be folded upwards and folded downwards with braked movement
- for mobile use
- for easy and flexible retrofitting on existing, preassembled mounting plate: 950.50.016, must be ordered separately
- toolless and quick installation by simple attachment of the hinged support rail
- secured by fixing screw to prevent unintentional removal
- tested up to 150 kg when used with HEWI fixing material
- Recommended maximum weight of the user: 150 kg
- Projection 700 mm , Height 252 mm and width 78 mm , Rail 33 mm in diameter
- With continuous, corrosion-protected steel core - made of high-quality, matte polyamide in HEWI colour 99 (pure white), 98 (signal white), 97 (light grey), 95 (stone grey) and 92 (anthracite grey)
- Toilet roll holder 801.50B011, WC flush release (radio) 801.50B060 retrofittable
- is produced in accordance with CE and UKCA Regulation (EU) 2017/745 on medical devices

Awards



Certificates



Colours / Surfaces

	99 (pure white)
	98 (signal white)
	97 (light grey)
	95 (stone grey)

92 (anthracite grey)