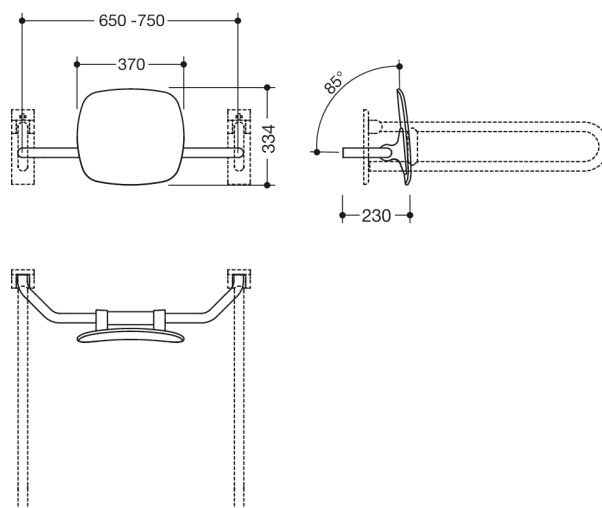



Photo similaire



Mesures en mm

### Propriétés













Dossier, série 801

- dossier avec barres de fixation des deux côtés
- distance de 230 mm par rapport au mur pour une utilisation facile
- sert à soutenir le dos sur le WC
- montage sur des barres d'appui relevables ou des poignées d'appui murales avec plaque murale, réglable sur place
- 650 à 750 mm de large, 230 mm de profondeur, dossier 334 mm de haut et 370 mm de large, diamètre des barres 33 mm
- avec noyau en acier inoxydable sur toute la longueur
- dossier en plastique dans la couleur HEWI 90 (noir foncé)
- raccord en polyamide brillant selon le nuancier HEWI

### Awards



### Couleurs / Surfaces

	99 (blanc pur)		92 (gris anthracite)		55 (bleu aqua)
	98 (blanc signalis.)		90 (noir foncé)		50 (bleu acier)
	97 (gris clair)		86 (sable)		33 (rouge rubis)
	95 (gris souris)		84 (umbra)		18 (jaune moutarde)