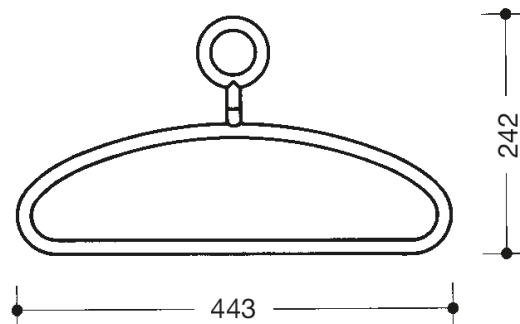



Photo similaire













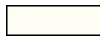





Mesures en mm

Propriétés

Cintre porte-pantalon

- en polyamide de haute qualité, par selon nuancier HEWI
- diamètre 15 mm, 242 x 443 mm, adapté pour diamètre de barre 33 mm
- anneau rotatif avec 4 points d'arrêt à 90°

Couleurs / Surfaces

 99 (blanc pur)	 92 (gris anthracite)	 74 (vert pomme)	 36 (corail)
 98 (blanc signalis.)	 90 (noir foncé)	 72 (vert mai)	 33 (rouge rubis)
 97 (gris clair)	 86 (sable)	 55 (bleu aqua)	 24 (orange)
 95 (gris souris)	 84 (umbra)	 50 (bleu acier)	 18 (jaune moutarde)