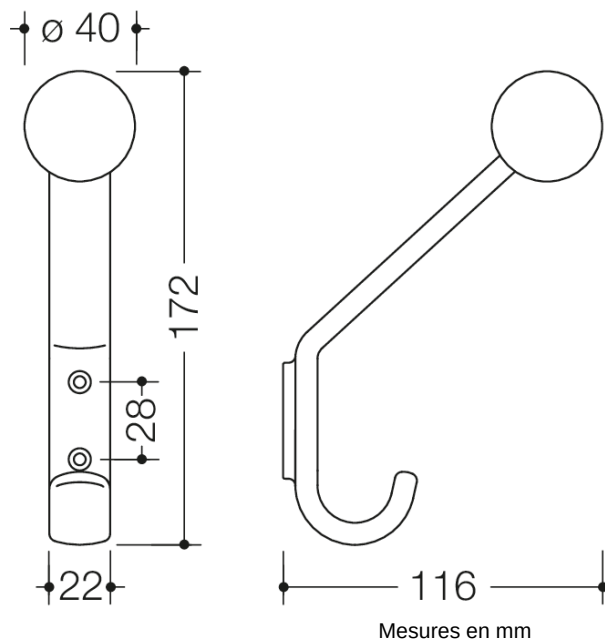



Photo similaire



Propriétés















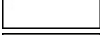

Crochet pour porte-manteau de la serie 477

- crochet avec porte-chapeaux en forme de boule
- sert à suspendre du linge et d'autres accessoires
- 172 mm de haut, 22 mm de large et 116 mm de profondeur
- en polyamide de haute qualité par HEWI table de couleurs

Awards



Couleurs / Surfaces

 99 (blanc pur)	 92 (gris anthracite)	 74 (vert pomme)	 36 (corail)
 98 (blanc signalis.)	 90 (noir foncé)	 72 (vert mai)	 33 (rouge rubis)
 97 (gris clair)	 86 (sable)	 55 (bleu aqua)	 24 (orange)
 95 (gris souris)	 84 (umbra)	 50 (bleu acier)	 18 (jaune moutarde)