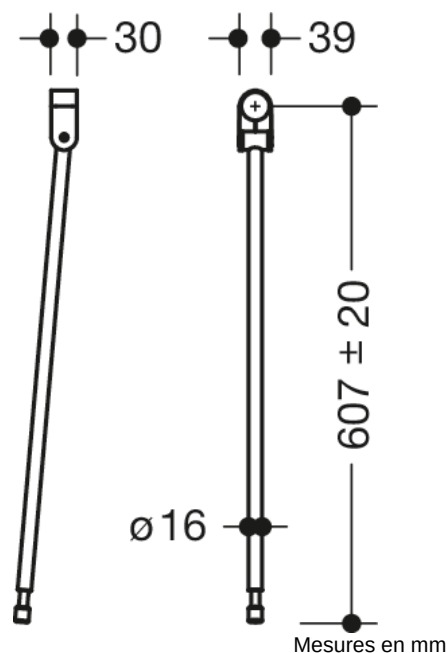



Photo similaire



Propriétés

Appui au sol

- appui au sol vertical pour un montage ultérieur sur les barres d'appui relevables et les barres d'appui 801.50...
- hauteur de montage 760 mm (remplit les demandes d'hauteur d'après DIN 18040)
- montage facile
- élément de raccordement en polyamide de haute qualité selon la table de couleurs HEWI
- support en acier protégé contre la corrosion de haute qualité, surface brossée mate
- longueur verticale 607 mm
- adaptable en hauteur de +/- 20 mm
- produit conformément au règlement CE et UKCA (UE) 2017/745 relatif aux dispositifs médicaux















Awards



Certificats



Couleurs / Surfaces

 99 (blanc pur)	 92 (gris anthracite)	 74 (vert pomme)	 33 (rouge rubis)
 98 (blanc signalis.)	 90 (noir foncé)	 55 (bleu aqua)	 18 (jaune moutarde)
 97 (gris clair)	 86 (sable)	 50 (bleu acier)	
 95 (gris souris)	 84 (umbra)	 36 (corail)	