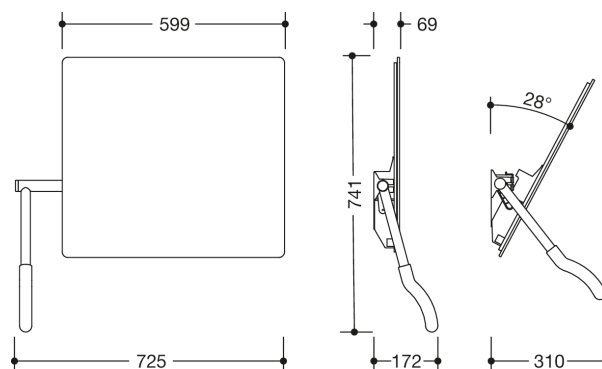



Photo similaire



Mesures en mm

Propriétés

Miroir inclinable de la série 802 LifeSystem (poigné gauche)















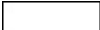

- miroir cristal rectangulaire à bords biseautés et protection contre les éclats intégrée
- réglage aisé de l'inclinaison en position assise, de 0 à 28°
- poignée gauche
- largeur 725 mm, hauteur 741 mm, profondeur du miroir 69 mm, écart (cote intérieure) entre le mur et la poignée 139 mm
- poignée-barre en laiton chromé brillant, axe en aluminium brossé et anodisé en couleur E6 EV1
- avec poignée ergonomique en polyamide par selon nuancier HEWI
- matériel de fixation anti-corrosion HEWI inclus

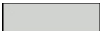
Awards



reddot design award
winner 2003

Couleurs / Surfaces

 99 (blanc pur)	 92 (gris anthracite)	 74 (vert pomme)	 36 (corail)
 98 (blanc signalis.)	 90 (noir foncé)	 72 (vert mai)	 33 (rouge rubis)
 97 (gris clair)	 86 (sable)	 55 (bleu aqua)	 24 (orange)
 95 (gris souris)	 84 (umbra)	 50 (bleu acier)	 18 (jaune moutarde)