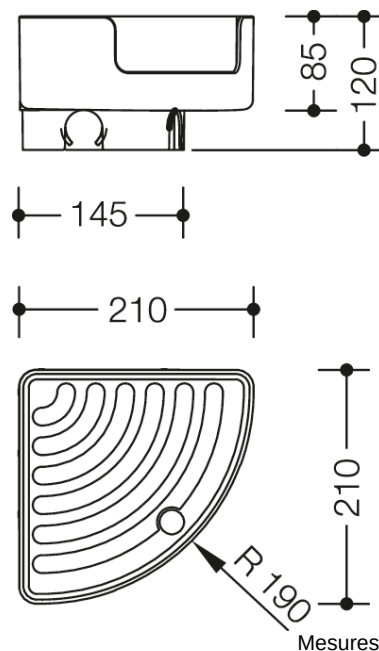

Photo similaire



Mesures en mm

Propriétés

Tablette d'angle de la série 802 LifeSystem











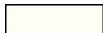



- tablette d'angle droit et formant un quart de cercle avec parois latérales hautes et écoulement de l'eau
- sert au rangement d'accessoires
- évidement à l'avant
- charge admissible 3 kg
- fond avec écoulement en pente et profil anti-dérapant
- à embrocher sur le système de barres de 33 mm de diamètre
- dimension latérale 210 mm, 120 mm de haut
- en polyamide de haute qualité, par selon nuancier HEWI

Awards

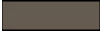

reddot design award
winner 2003

Couleurs / Surfaces

 99 (blanc pur)	 92 (gris anthracite)	 74 (vert pomme)	 36 (corail)
 98 (blanc signalis.)	 90 (noir foncé)	 72 (vert mai)	 33 (rouge rubis)
 97 (gris clair)	 86 (sable)	 55 (bleu aqua)	 24 (orange)
 95 (gris souris)	 84 (umbra)	 50 (bleu acier)	 18 (jaune moutarde)