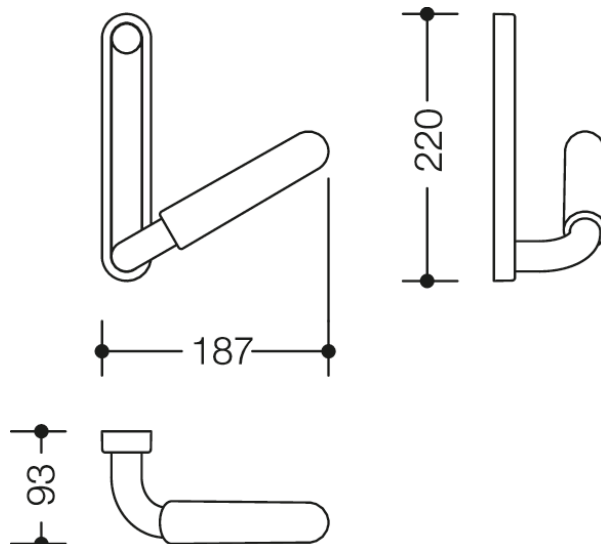



Photo similaire



Mesures en mm

### Propriétés

Barre de maintien de la série 802 LifeSystem avec plaque, version gauche

- poignée chromée avec poignée en plastique montée sur plaque
- sert à se tenir et à se redresser seul
- inclinaison des poignées de maintien réglable en pas de 30°
- Exécution du point de vue du gauche de l'utilisateur
- 187 mm de large, 220 mm de haut, 93 mm de profondeur
- plaque et barre en aluminium chromé brillant et éléments de design peints par poudrage mats
- poignée en polyamide au toucher agréable par selon nuancier HEWI
- produit conformément au règlement CE et UKCA (UE) 2017/745 relatif aux dispositifs médicaux
- matériel de fixation anti-corrosion HEWI inclus















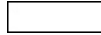

### Awards



### Certificats



### Couleurs / Surfaces

 99 (blanc pur)	 92 (gris anthracite)	 74 (vert pomme)	 36 (corail)
 98 (blanc signalis.)	 90 (noir foncé)	 72 (vert mai)	 33 (rouge rubis)
 97 (gris clair)	 86 (sable)	 55 (bleu aqua)	 24 (orange)
 95 (gris souris)	 84 (umbra)	 50 (bleu acier)	 18 (jaune moutarde)