

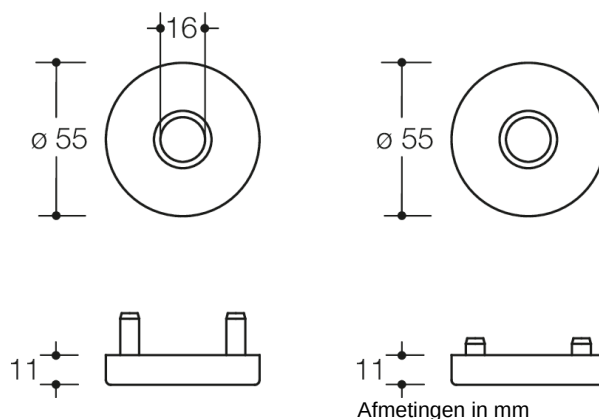

Vergelijkbare afbeelding



Eigenschappen

Krukrozet

in R-techniek van polyamide door en door gekleurd, oppervlak hoogglanzend, en voor deurkruk halstdiameter 20 mm

Onderconstructie voor rozetten in kunststof-roestvrij staal verbingsconstructie, DIN links en DIN rechts toepasbaar. Verborgene, betrouwbare schroefverbinding met combinatie van M4 schroeven en hulsschroeven en steunpenen binnenin het deurblad.







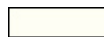

Afdekkap voor rozetten, rond, diameter 55 mm, 10,5 mm hoog, vlak, 1,5 mm wanddikte.

Levering incl. schroeven

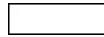
Certificaten



Kleuren / Oppervlakken

	99 (zuiverwit)		92 (antraciegrijs)		18 (mosterdgeel)
	98 (signaalwit)		90 (diepzwart)		
	97 (lichtgrijs)		50 (staalblauw)		
	95 (rotsgrijs)		33 (robijnrood)		