

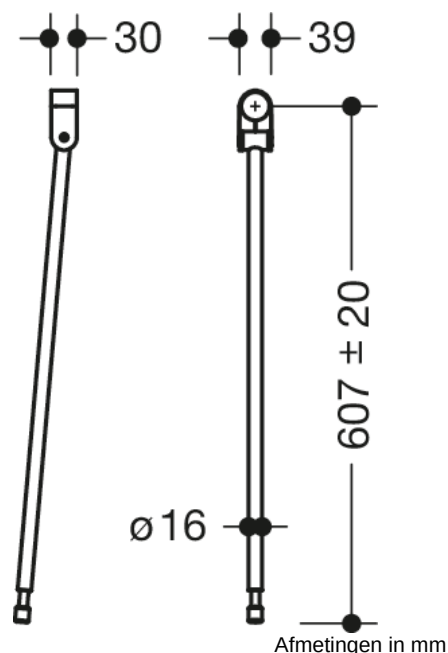

Vergelijkbare afbeelding



Eigenschappen

Vloersteun

- verticale steun om achteraf aan te brengen bij opklapbare steunen en wandsteunen 801.50...
- montagehoogte 760 mm (om aan de hoogte-eisen conform DIN 18040 te voldoen)
- eenvoudige montage
- Verbinding van hoogwaardige polyamide conform de HEWI kleurtabel
- steun van hoogwaardige rvs, oppervlak mat gepolijst
- verticale lengte 607 mm
- Hoogteverstelling in het bereik +/- 20 mm mogelijk
- geproduceerd in overeenstemming met CE- en UKCA-Verordening (EU) 2017/745 betreffende medische hulpmiddelen















Awards



Certificaten



Kleuren / Oppervlakken

 99 (zuiverwit)	 92 (antraciegrijs)	 74 (appelgroen)	 33 (robijnrood)
 98 (signaalwit)	 90 (diepzwart)	 55 (aqua blauw)	 18 (mosterdgeel)
 97 (lichtgrijs)	 86 (zand)	 50 (staalblauw)	
 95 (rotsgrijs)	 84 (omber)	 36 (koraal)	