

Bilde lignende

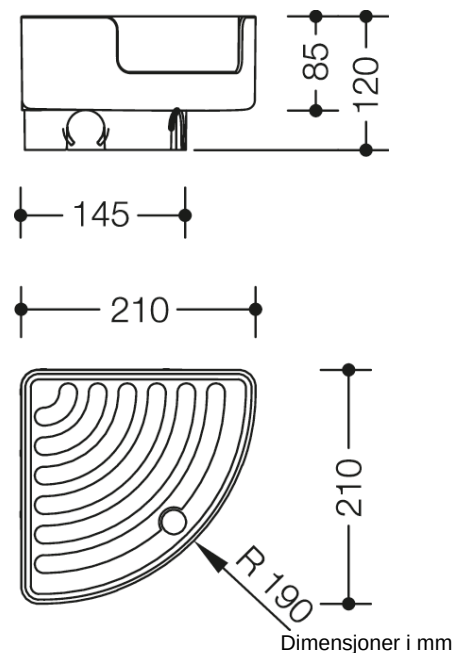

Egenskaper

Serie 802 LifeSystem hjørnehylle







- Hylle formet i rett vinkel med en kvart sirkel, høye sidevegger og vanddrenering
- Brukes til oppbevaring av tilbehør
- Fordypning på forsiden
- Lastkapasitet 3 kg
- Gulv med vanddreneringshelling og sklisikker profil
- For feste til stangsystem med diameter 33 mm
- Sidelengder 210 mm, 120 mm høy
- laget av polyamid av høy kvalitet i henhold til HEWI fargekart

Utmerkelser og æresbevisninger



reddot design award
winner 2003

Farger/overflater

 99 (ren hvit)	 92 (antracitegrå)	 74 (eplegrønn)	 36 (korall)
 98 (signal hvitt)	 90 (dyp svart)	 72 (kan grønn)	 33 (rubin rød)
 97 (lysegrå)	 86 (sand)	 55 (aquablå)	 24 (orange)
 95 (steingrå)	 84 (umbra)	 50 (stålblå)	 18 (sennep gul)

Med forbehold om tekniske endringer, 15.05.2026