

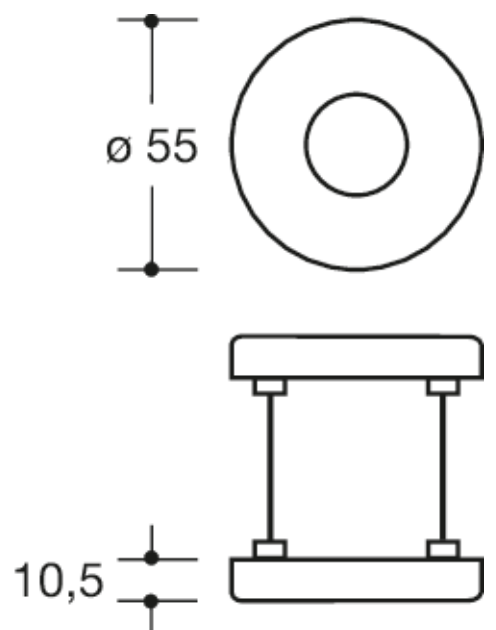

Vergelijkbare afbeelding



Afmetingen in mm

Eigenschappen

Krukrozet

korte nokken, in R-techniek van polyamide door en door gekleurd, oppervlak hoogglanzend, en voor deurkruk
halsdiameter 20 mm

Onderconstructie voor rozetten in kunststof-roestvrij staal verbidingsconstructie, DIN links en DIN rechts
toepasbaar. Verborgen, betrouwbare schroefverbinding met combinatie van M4 schroeven en hulsschroeven en
steunpen binnenin het deurblad.

Afdekkap voor rozetten, rond, diameter 55 mm, 10,5 mm hoog, vlak, 1,5 mm wanddikte.

Levering zonder schroeven

Kleuren / Oppervlakken

 18 (mosterdgeel)	 50 (staalblauw)	 86 (zand)	 97 (lichtgrijs)
 24 (oranje)	 55 (aqua blauw)	 90 (diepzwart)	 98 (signaalwit)
 33 (robijnrood)	 72 (meigroen)	 92 (antraciegrijs)	 99 (zuiverwit)
 36 (koraal)	 84 (omber)	 95 (rotsgrijs)	 74 (appelgroen)