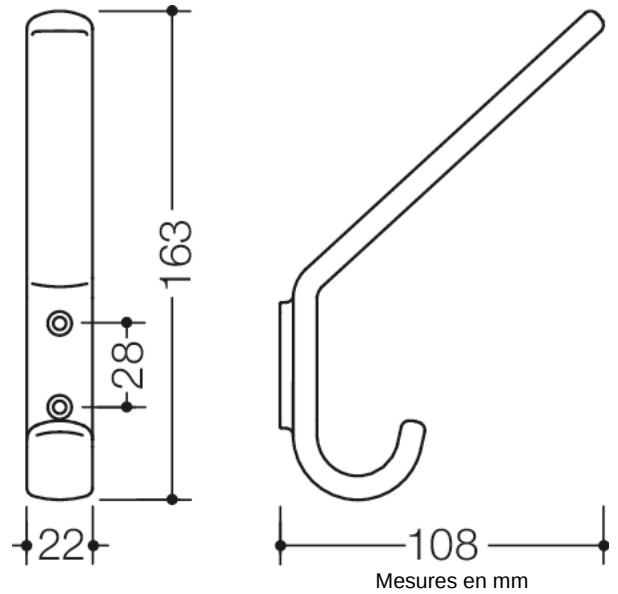



Photo similaire



### Propriétés















Crochet pour porte-manteau de la serie 477

- crochet et porte-chapeau
- sert à suspendre du linge et d'autres accessoires
- 163 mm de haut, 22 mm de large et 108 mm de profondeur
- en polyamide de haute qualité par HEWI table de couleurs

### Awards

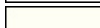

### Couleurs / Surfaces

 18 (jaune moutarde)	 50 (bleu acier)	 86 (sable)	 97 (gris clair)
 24 (orange)	 55 (bleu aqua)	 90 (noir foncé)	 98 (blanc signalis.)
 33 (rouge rubis)	 72 (vert mai)	 92 (gris anthracite)	 99 (blanc pur)
 36 (corail)	 84 (umbra)	 95 (gris souris)	 74 (vert pomme)