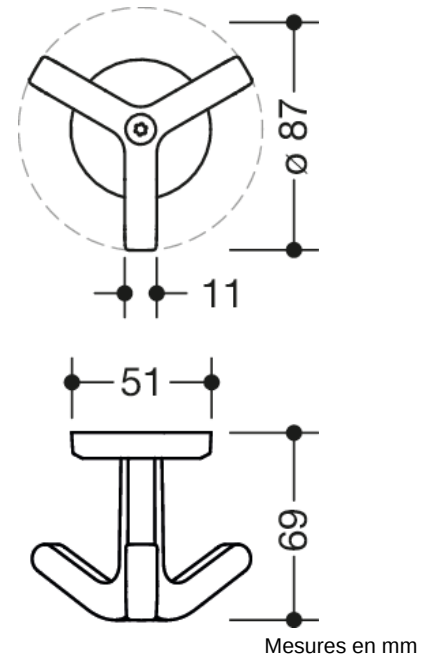



Photo similaire



Propriétés











Crochet triple de la série 477 dans un nouveau design

- sert à suspendre des vêtements et d'autres accessoires
- bords arrondis
- crochet rotatif à visser par en dessous
- diamètre de rosace de 51 mm
- l : 80 mm, H : 69 mm
- en polyamide brillant dans les couleurs HEWI sélectionnées 99, 97, 95, 92, 90, 18, 33, 74, 55, 50 (nuancier HEWI)
- fixation cachée
- Marquage GS (sécurité testée par le TÜV)

Certificats



Couleurs / Surfaces

	99 (blanc pur)		90 (noir foncé)		33 (rouge rubis)
	97 (gris clair)		74 (vert pomme)		18 (jaune moutarde)
	95 (gris souris)		55 (bleu aqua)		
	92 (gris anthracite)		50 (bleu acier)		