

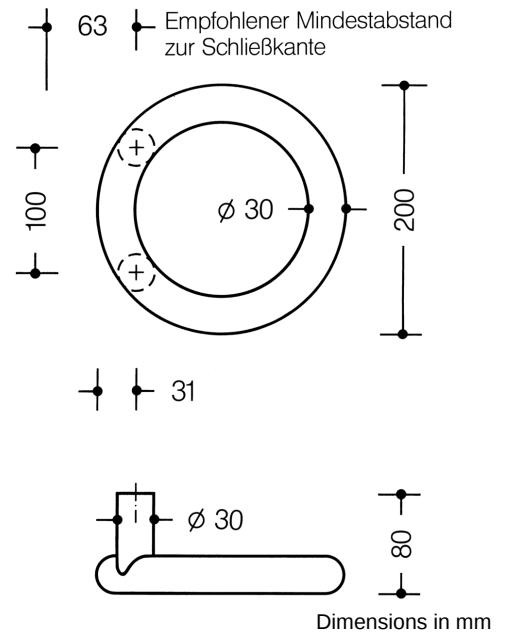

Similar picture



### Properties





#### Pull handle



System 111 made of solid coloured polyamide, diameter 30 mm, for one-sided and paired fixing on glass, wooden, PVC and metal doors (aluminium: 1 to 3 chamber, steel: 1 chamber profiles), Load bearing capacity under alternating load 100 kg on wooden and metal doors, 50 kg on PVC doors, with 2 fixing points, fixing outside the lock area or within the lock area, as well as fixing through the lock. Round handle diameter 30 mm, center-to-center 100 mm, with straight supports, for mounting on leaf doors, in conjunction with BA5.0 for frame doors, fulfils the handle requirements of the guidelines of the German Federal Association of Accident Insurance Funds (Bundesverband der Unfallkassen e. V. - BUK) - safe distance from the closing edge 25 mm.

centre-to-centre 100 mm

Attention: Rosette fixing only possible with BA...30STG!

### Colours / Surfaces

	99 (pure white)
	98 (signal white)
	97 (light grey)
	95 (stone grey)

	92 (anthracite grey)
	90 (jet black)