

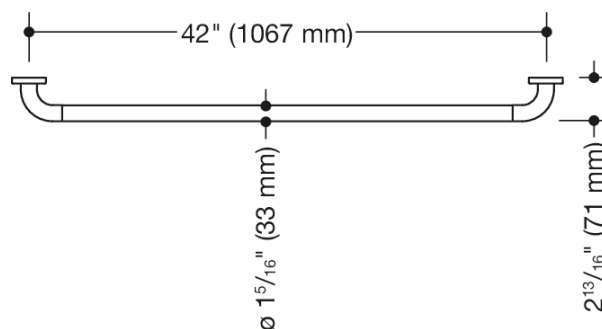

Similar picture



Dimensions in mm

### Properties

Grab bar (USA) from Range 801

- rail curved at right-angles at the ends with steel fixing roses
- for holding onto and as a support
- with corrosion-protected steel core throughout
- wall mounting with wall-specific fixing material and roses from HEWI
- c to c 42 inch (1067 mm), 2 3/4 inch (70 mm) deep
- rail diameter 1 5/16 inch (33 mm), rose diameter 2 3/4 inch (70 mm)
- maximum loading capacity 250 lbs (114 kg)
- made from high-grade synthetic material in the HEWI colors 99 (pure white), 95 (stone grey), 92 (anthracite grey), 90 (jet black), 86 (sand), 84 (umber) and 33 (ruby red)
- meets the requirements of 2010 ADA standards and ICC/ANSI A117.1-2017
- toilet paper holder upgrade kit 801.50US010 can be retrofitted





### Awards





### Certificates



### Colours / Surfaces

	99 (pure white)
	95 (stone grey)
	92 (anthracite grey)
	90 (jet black)

	86 (sand)
	84 (umber)
	33 (ruby red)