

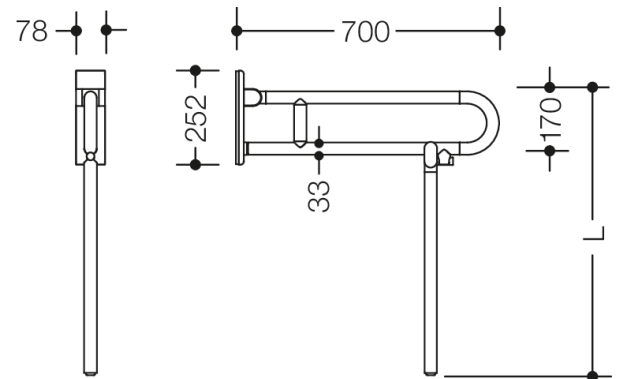

Similar picture



Dimensions in mm

### Properties

Range 801 mobile hinged support rail (rotatable)

- with floor support made to measure
- two parallel rails running one above the other joined by a connecting bend
- for holding on to and providing support
- weight capacity 100 kg
- with continuous, corrosion resistant steel core
- can be folded upwards and, folded downwards with braking mechanism, in raised position can be turned to left or right towards the wall
- for mobile use
- for easy and flexible retrofitting on existing, preassembled mounting plate 950.50.016, must be ordered separately
- toolless and quick installation by simple attachment of the mobile hinged support rail
- secured by fixing screw to prevent unintentional removal
- 700 mm projection, 252 mm high and 78 mm deep, 33 mm rail diameter
- made of high-quality matt polyamide in HEWI colours 99 (pure white), 98 (signal white), 97 (light grey), 95 (stone grey) and 92 (anthracite grey)
- toilet roll holder 801.50B011 and WC flushing mechanism (radio-controlled) 801.50B060 for retrofitting
- produced in accordance with CE- and UKCA-Regulation (EU) 2017/745 on medical devices

### Certificates



### Colours / Surfaces

	99 (pure white)
	98 (signal white)
	97 (light grey)
	95 (stone grey)

92 (anthracite grey)