

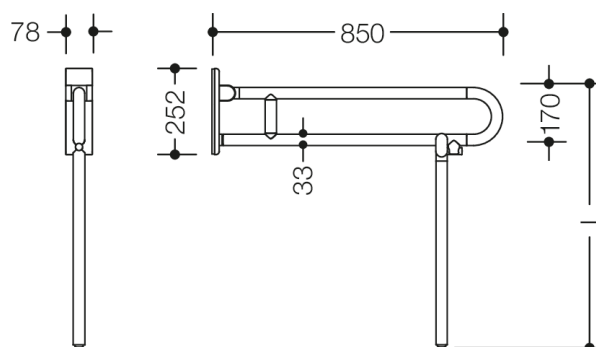

Similar picture



Dimensions in mm

Properties

Range 801 mobile hinged support rail (rotatable)

- with floor support made to measure
- two parallel rails running one above the other joined by a connecting bend
- for holding on to and providing support
- weight capacity 100 kg
- with continuous, corrosion resistant steel core
- can be folded upwards and, folded downwards with braking mechanism, in raised position can be turned to left or right towards the wall
- for mobile use
- for easy and flexible retrofitting on existing, preassembled mounting plate 950.50.016, must be ordered separately
- toolless and quick installation by simple attachment of the mobile hinged support rail
- secured by fixing screw to prevent unintentional removal
- 850 mm projection, 252 mm high and 78 mm deep, 33 mm rail diameter
- made of high-quality polyamide according to HEWI colour chart
- toilet paper holder upgrade kit 801.50.011 and toilet flushing mechanism (radio) upgrade kit 801.50.060 for retrofitting
- produced in accordance with CE- and UKCA-Regulation (EU) 2017/745 on medical devices

Certificates



Colours / Surfaces

 33 (ruby red)	 74 (apple green)	 92 (anthracite grey)	 99 (pure white)
 36 (coral)	 18 (mustard yellow)	 95 (stone grey)	 84 (umber)
 50 (steel blue)	 86 (sand)	 97 (light grey)	
 55 (aqua blue)	 90 (jet black)	 98 (signal white)	