

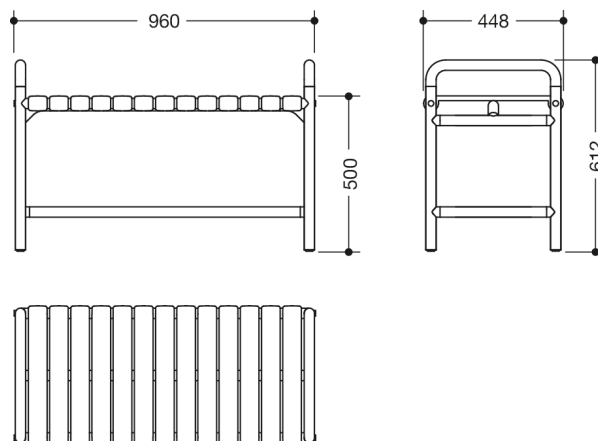

Podobne zdjęcie











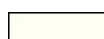

Wymiary w mm

### Właściwości

Ławka prysznicowa seria 801

- przeznaczona do stosowania pod prysznicem
- konstrukcja z drążków o śr. 33 mm z odpronym na korozję stalowym rdzeniem
- maks. obciążenie do 350 kg powierzchnia
- przenośna
- szer. 960 mm, gł. 448 mm, wys. siedzenia 500 mm, całkowita wys. 612 mm, elementy siedzenia szer. 55 mm
- z wysokiej jakości poliamidu w kolorach HEWI

### Kolory / Powierzchnie

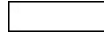
 33 (rubinowa czerwień)	 74 (jabłko zielone)	 92 (szary antracytowy)	 99 (czysta biel)
 36 (koral)	 18 (żółta musztarda)	 95 (szary kamień)	 84 (umbra)
 50 (stalowoniebieski)	 86 (piasek)	 97 (jasnoszary)	
 55 (błękit akwaticzny)	 90 (czerń jetowa)	 98 (sygnał biały)	