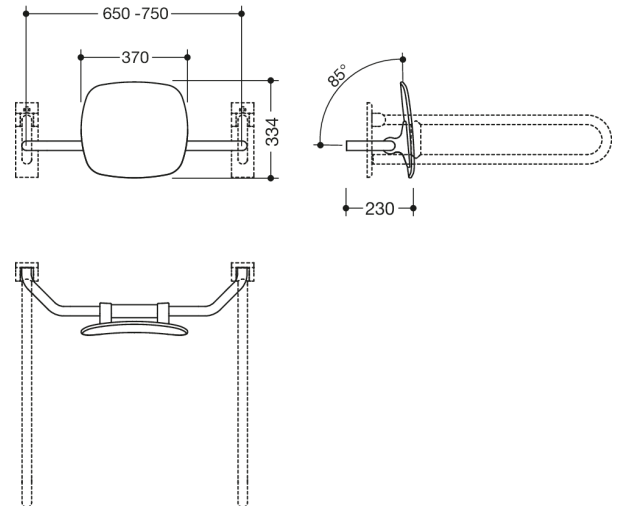



Photo similaire

















Mesures en mm

Propriétés

Dossier, série 801

- dossier avec barres de fixation des deux côtés
- distance de 230 mm par rapport au mur pour une utilisation facile
- sert à soutenir le dos sur le WC
- montage sur des barres d'appui relevables ou des poignées d'appui murales avec plaque murale, réglable sur place
- 650 à 750 mm de large, 230 mm de profondeur, dossier 334 mm de haut et 370 mm de large, diamètre des barres 33 mm
- avec noyau en acier inoxydable sur toute la longueur
- dossier en plastique dans la couleur HEWI 92 (gris anthracite)
- raccord en polyamide brillant selon le nuancier HEWI

Couleurs / Surfaces

| | | | |
|--|---|--|--|
|  33 (rouge rubis) |  74 (vert pomme) |  92 (gris anthracite) |  99 (blanc pur) |
|  36 (corail) |  18 (jaune moutarde) |  95 (gris souris) |  84 (umbra) |
|  50 (bleu acier) |  86 (sable) |  97 (gris clair) | |
|  55 (bleu aqua) |  90 (noir foncé) |  98 (blanc signalis.) | |