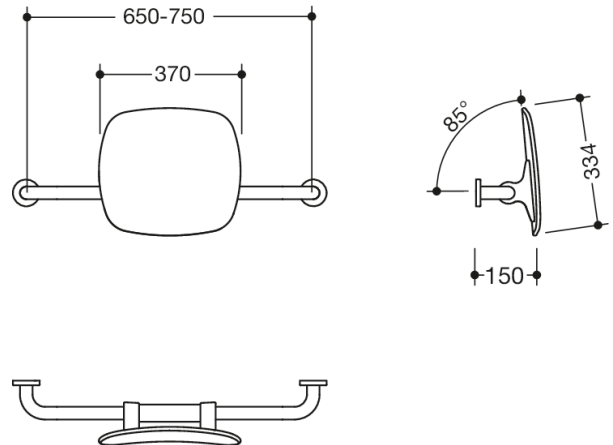



Photo similaire















Mesures en mm

Propriétés

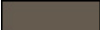
Dossier, série 801

- dossier avec barres de fixation coudées en angle droit des deux côtés et rosaces de fixation
- sert à soutenir le dos sur le WC
- montage au mur avec des rosaces
- 650 à 750 mm de large, 150 mm de profondeur, dossier 334 mm de haut et 370 mm de large, diamètre des barres 33 mm, diamètre des rosaces 70 mm
- avec noyau en acier inoxydable sur toute la longueur
- dossier en plastique dans la couleur HEWI 98 (blanc de sécurité)
- raccord en polyamide brillant selon le nuancier HEWI
- répond aux exigences des normes DIN 18040 et ÖNORM B1600/1601

Couleurs / Surfaces

 33 (rouge rubis)	 74 (vert pomme)	 92 (gris anthracite)	 99 (blanc pur)
 36 (corail)	 18 (jaune moutarde)	 95 (gris souris)	 84 (umbra)
 50 (bleu acier)	 86 (sable)	 97 (gris clair)	
 55 (bleu aqua)	 90 (noir foncé)	 98 (blanc signalis.)	