

Similar picture

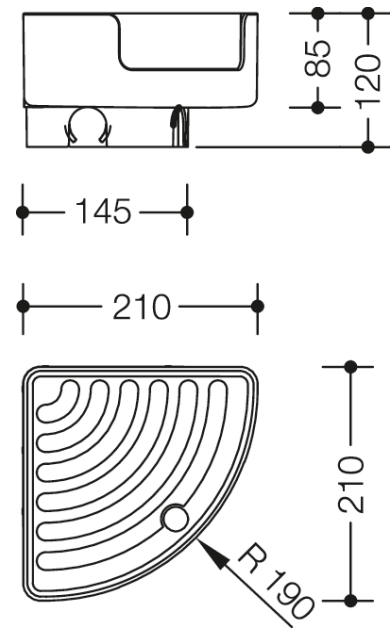

Dimensions in mm

Properties















Range 802 LifeSystem Corner shelf

- right-angled corner shelf with rounded front, high sides and drainage feature
- used to store accessories
- opening at the front
- loading capacity 3 kg
- base with inclined draining surfaces and non-slip profile
- for integration in the 33 diameter rail system
- side lengths 210 mm, 120 mm high
- made of high-quality polyamide according to HEWI colour chart

Awards



Colours / Surfaces

| | | | |
|---|---|--|---|
|  24 (orange) |  55 (aqua blue) |  86 (sand) |  97 (light grey) |
|  33 (ruby red) |  72 (may green) |  90 (jet black) |  98 (signal white) |
|  36 (coral) |  74 (apple green) |  92 (anthracite grey) |  99 (pure white) |
|  50 (steel blue) |  18 (mustard yellow) |  95 (stone grey) |  84 (umber) |