

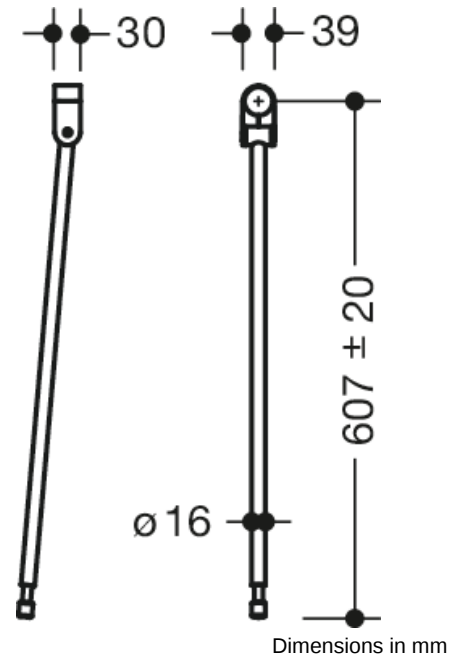

Similar picture



Properties















Floor support

- vertical floor support for retrofitting on hinged support rails and stationary support rails 801.50...
- installation height 760 mm (to fulfil the DIN 18040 height requirements)
- easy installation
- connection made of high-quality polyamide according to HEWI colour chart
- support made of high-quality stainless steel with satin
- vertical length 607 mm
- height adjustment within +/- 20 mm range possible
- produced in accordance with CE- and UKCA-Regulation (EU) 2017/745 on medical devices

Certificates



Colours / Surfaces

 33 (ruby red)	 74 (apple green)	 92 (anthracite grey)	 99 (pure white)
 36 (coral)	 18 (mustard yellow)	 95 (stone grey)	 84 (umber)
 50 (steel blue)	 86 (sand)	 97 (light grey)	
 55 (aqua blue)	 90 (jet black)	 98 (signal white)	