

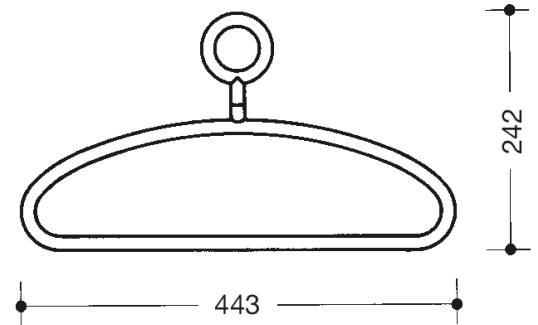

Similar picture



















Dimensions in mm

Properties

Coat and trouser hanger

- made of high-quality polyamide, according to HEWI colour chart
- diameter 15 mm, 242 x 443 mm, fits on rail diameter 33 mm
- with rotatable eye, with 90° locking points

Colours / Surfaces

	99 (pure white)		92 (anthracite grey)		74 (apple green)		36 (coral)
	98 (signal white)		90 (jet black)		72 (may green)		33 (ruby red)
	97 (light grey)		86 (sand)		55 (aqua blue)		24 (orange)
	95 (stone grey)		84 (umber)		50 (steel blue)		18 (mustard yellow)