

MOBILE HINGED SUPPORT RAILS

NECESSARY

OPTIONAL
SEPARATELY



900.50.400..* | Mono

- stainless steel, optionally satin finish, chrome-plated, powder-coated in 3 colours or PVD-coated
- projection: 600 mm

+



900.50.001XA

- mounting plate made of stainless steel, satin finish

OPTIONAL



900.50.002XA

- cover for covering fixed mounting plates
- face plate made of stainless steel, satin finish
- cover frame made of polyamide in HEWI colours 98 (signal white) or 92 (anthracite grey)

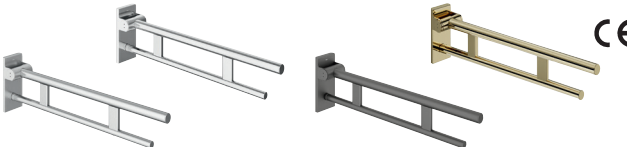

900.50.40..* | Duo

- stainless steel, optionally satin finish, chrome-plated, powder-coated in 3 colours or PVD-coated
- projection: 600, 700, 750, 850, 900 mm

+



900.50.00140

- mounting plate made of stainless steel, chrome-plated

OPTIONAL



900.50.00240

- cover for covering fixed mounting plates
- face plate made of stainless steel, mirror polished
- cover frame made of polyamide in HEWI colours 98 (signal white) or 92 (anthracite grey)

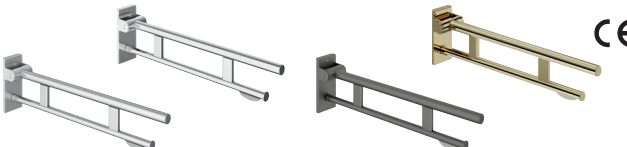

900.50.40..* | with toilet roll holder

- stainless steel, optionally satin finish, chrome-plated, powder-coated in 3 colours or PVD-coated
- projection: 700, 750, 850, 900 mm

+



900.50.00160

- mounting plate made of stainless steel, powder-coated in 3 colours: DX (matt white), SC (matt dark grey pearl mica) or DC (matt black)

OPTIONAL



900.50.00260

- cover for covering fixed mounting plates
- face plate made of stainless steel, powder-coated in AS (matt white) or CV (matt black)
- cover frame in matching matt white or matt black

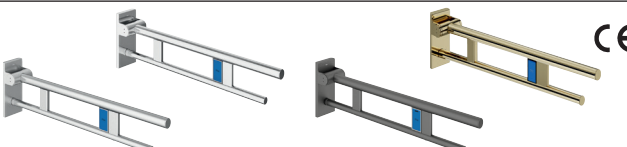

900.50.4..* | with toilet flushing solution (radio)

- stainless steel, optionally satin finish, chrome-plated, powder-coated in 3 colours or PVD-coated
- projection: 700, 750, 850, 900 mm
- left and right version

+



900.50.00170*

- mounting plate made of stainless steel, PVD-coated in CK (brass glossy), LP (brass brushed), WR (nickel brushed), SV (bronze brushed)*





900.50.41..* | with toilet roll holder and toilet flushing solution (radio)

- stainless steel, optionally satin finish, chrome-plated, powder-coated in 3 colours or PVD-coated
- projection: 700, 750, 850, 900 mm
- left and right version

+





HEWI Powder coating | Material combinations with synthetic material

-  ...60 AS matt white | white synthetic material
-  ...60 ER matt dark grey pearl mica | black synthetic material
-  ...60 CV matt black | black synthetic material

HEWI Powder coating

-  ...60 DX matt white
-  ...60 SC matt dark grey pearl mica
-  ...60 DC matt black

HEWI PVD-coating | delivery time 4 weeks

-  ...70 CK brass glossy
-  ...70 LP brass brushed
-  ...70 WR nickel brushed
-  ...70 SV bronze brushed

OR SET

NECESSARY FOR ALL

OPTIONAL FOR ALL

OR

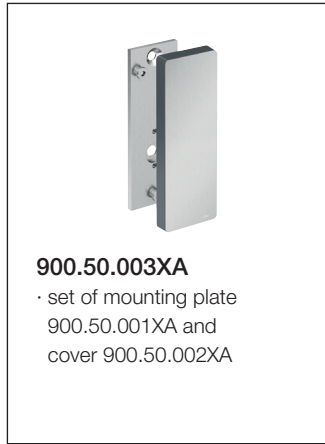

+

OR

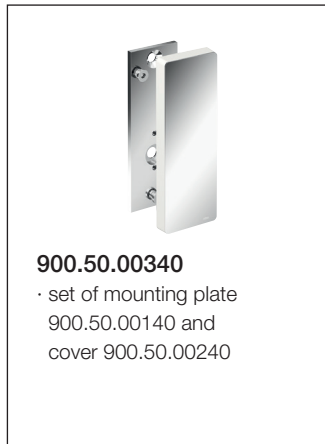

+

OR



+

OR



BM17.2
For fixing on walls made of concrete (> C20/C25)
National technical approval number: ETA-11/0493

additionally:
injection mortar (HEWI item No.: 200311)
or to be provided on site:
injection mortar HIT-HY200A (Hilti)
extrusion tool HDM (Hilti)

BM10.2
For fixing on walls made of concrete (> C20/C25)

BM11.2
For fixing on walls made of autoclaved aerated concrete (> P2)

additionally:
injection mortar (HEWI item No.: 200266)
conical drill bit (HEWI item No.: 171041)
or to be provided on site:
injection mortar HIT-HY 270 (Hilti)
extrusion tool HDM (Hilti)
conical drill bit TE-C PB 22/100 (Hilti)

BM12.2
For fixing on lightweight walls with rear lining made of laminated timber boards (with waterproof bonding, at least 30 mm thick required, e.g. studs or prewall installation)

BM13.2
For fixing on lightweight walls with integrated steel plates (e.g. studs or pre wall installation)

BM18.2
For fixing on walls made of:
· solid bricks
· perforated calcium silicate block
· hollow concrete block
· vertically perforated bricks
· hollow lightweight concrete block
· lightweight aggregate concrete with open structure
National technical approval number: ETA-13/1036

additionally:
injection mortar (HEWI item No.: 200266)
or to be provided on site:
injection mortar HIT-HY 270 (Hilti)
extrusion tool HDM (Hilti)

OPTIONAL

OPTIONAL

OPTIONAL



* HEWI PVD-coating | delivery time 12 weeks

- ...70 UN bronze glossy
- ...70 DP copper glossy
- ...70 RB copper brushed

- ...70 BZ gold glossy
- ...70 VT gold brushed
- ...70 JL nickel glossy