

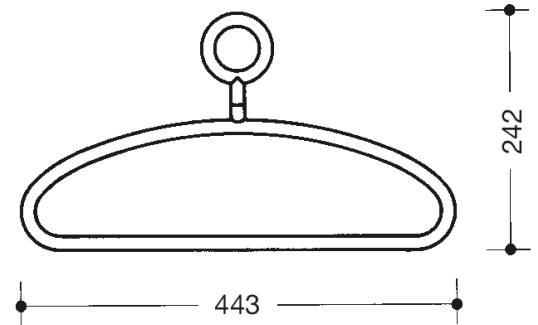

Similar picture



















Dimensions in mm

### Properties

Coat and trouser hanger

- made of high-quality polyamide, according to HEWI colour chart
- diameter 15 mm, 242 x 443 mm, fits on rail diameter 33 mm
- with rotatable eye, with 90° locking points

### Colours / Surfaces

|   |                   |   |                      |   |                  |   |                     |
|---|-------------------|---|----------------------|---|------------------|---|---------------------|
|  | 99 (pure white)   |  | 92 (anthracite grey) |  | 74 (apple green) |  | 36 (coral)          |
|  | 98 (signal white) |  | 90 (jet black)       |  | 72 (may green)   |  | 33 (ruby red)       |
|  | 97 (light grey)   |  | 86 (sand)            |  | 55 (aqua blue)   |  | 24 (orange)         |
|  | 95 (stone grey)   |  | 84 (umber)           |  | 50 (steel blue)  |  | 18 (mustard yellow) |